

SD3, SDP3 – Montage- und Bedienungsanleitung

Achtung
attention – attention

Kinder können sich in den Schlingen von Schnüren, Ketten oder Gurten zur Bedienung von Sicht- und Sonnenschutzeinrichtungen verfangen oder sich Schnüre um den Hals wickeln und sich unter Umständen dadurch strangulieren. Schnüre, Ketten und Gurte sind außer Reichweite von Kindern zu halten, um Verwicklungen und Strangulierungen zu vermeiden. Betten, Kinderbetten und Möbel sind entfernt von Bedienungen für Sicht- und Sonnenschutzeinrichtungen aufzustellen.

Children can get caught in the loops of cords, chains or straps that operate window coverings or they can wrap cords around their necks and strangle thereby. Keep cords, chains and straps out of reach of children to avoid entanglement and strangulation. Move beds, cots and furniture away from window covering operations.

Les enfants peuvent se prendre dans cordons, chaînettes ou courroies qui actionnent les stores de protection solaire et visuelle ou ils peuvent enrouler les cordons autour leur cou et ainsi s'étouffer. Maintenez les cordons, chaînettes et courroies hors de portée des enfants pour éviter de s'étouffer ou de s'emmeuler. Placez les lits, berceaux et meubles à l'écart des manipulations des stores de protection solaire et visuelle.

Entspricht EN 13120
according to EN 13120 – selon EN 13120

Plissees
pleated blinds – stores plissés

SD3, SDP3

Montage- und Bedienungsanleitung
*assembly and operating instructions
notice de montage et mode d'emploi*

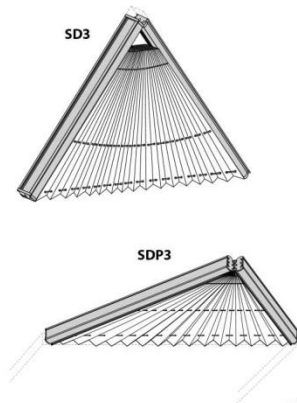

799 028 542

02 / 2012
Technische Änderungen bleiben vorbehalten
*subject to technical change
sous réserve de modifications techniques*

A Montage
fixation – montage

→ **Bitte nur beiliegende Schrauben verwenden!**
Please use enclosed screws only! – Se servir exclusivement des vis jointes!



DECKENCLIP
CEILING CLIP – CLIP PLAFOND

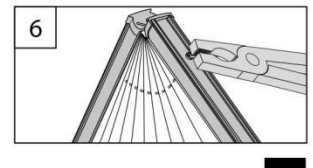
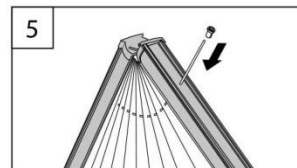
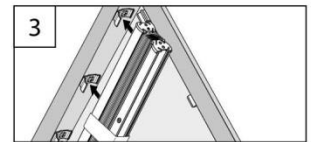
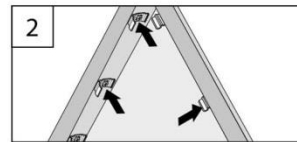
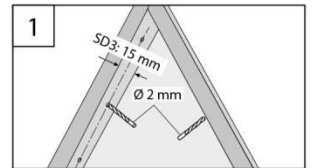
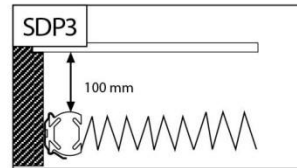

1

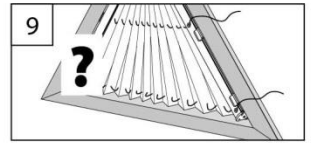
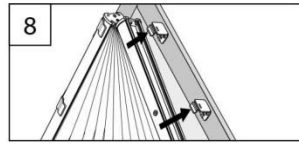
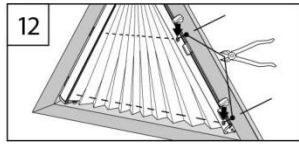
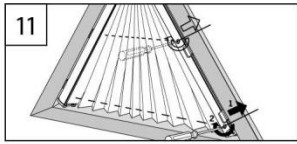
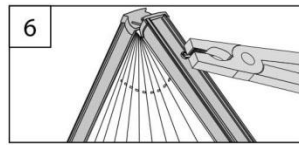
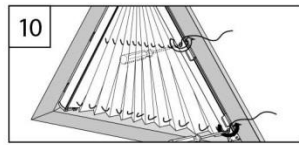
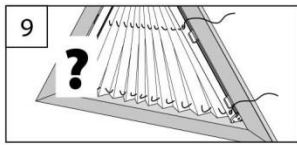
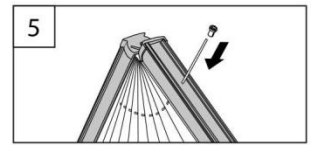
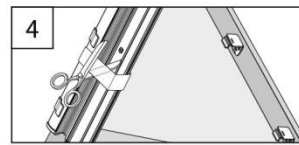
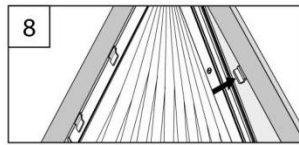

WANDWINKEL
WALL FIXING BRACKET - SUPPORT MURAL

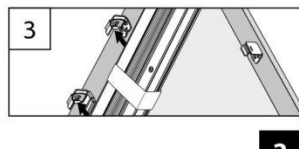
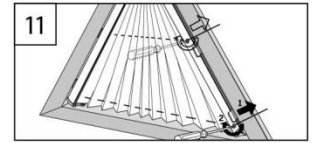
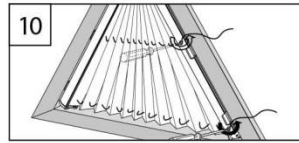
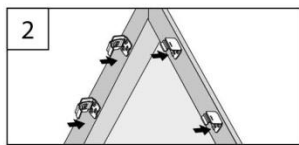
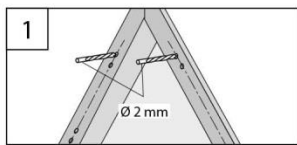

B Demontage
dismantling - démontage

DECKENCLIP
CEILING CLIP - CLIP PLAFOND

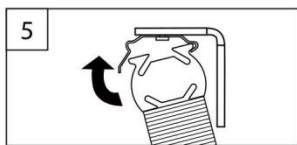
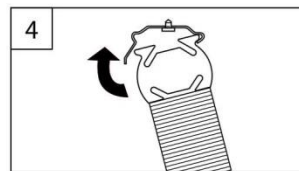
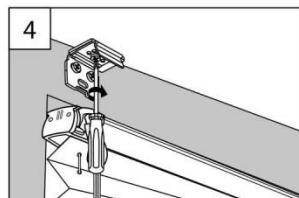
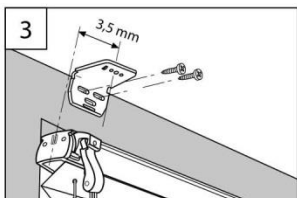
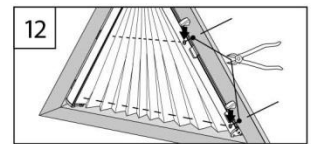

WANDWINKEL FÜR F SLOPE 4

WALL FIXING BRACKET CLIP FOR FD SLOPE 4 - SUPPORT MURAL POUR FD SLOPE 4

DECKENCLIP FÜR FD SLOPE 4
CEILING CLIP FOR FD SLOPE 4 - CLIP PLAFOND POUR FD SLOPE 4

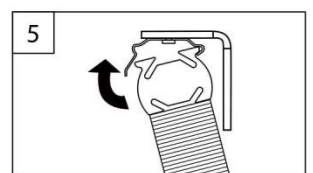
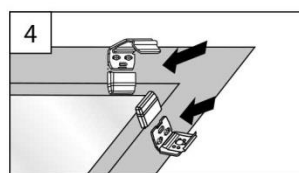
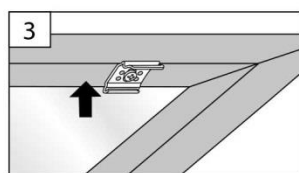
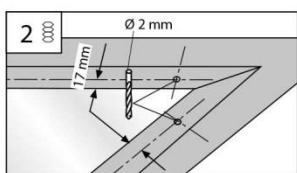
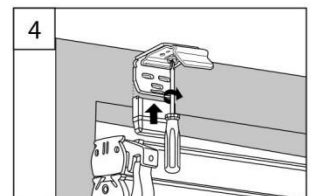
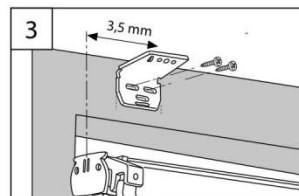
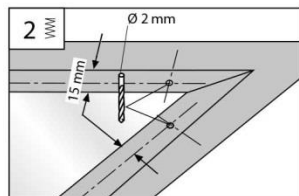
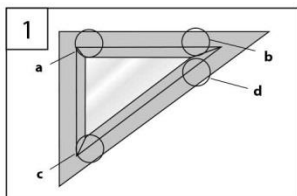
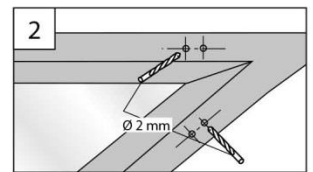
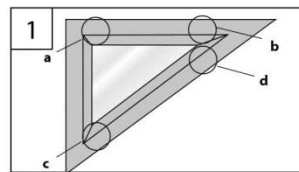

4

5

SCHNURWICKLER
CORD WINDER – SUPPORT DE CORDON

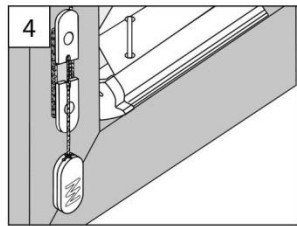
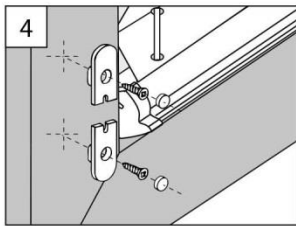

B Demontage
dismantling – démontage

DECKENCLIP
CEILING CLIP – CLIP PLAFOND

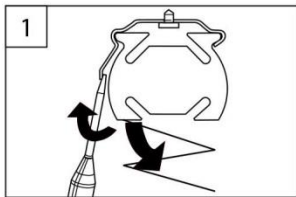

C Bedienung
operation – manipulation

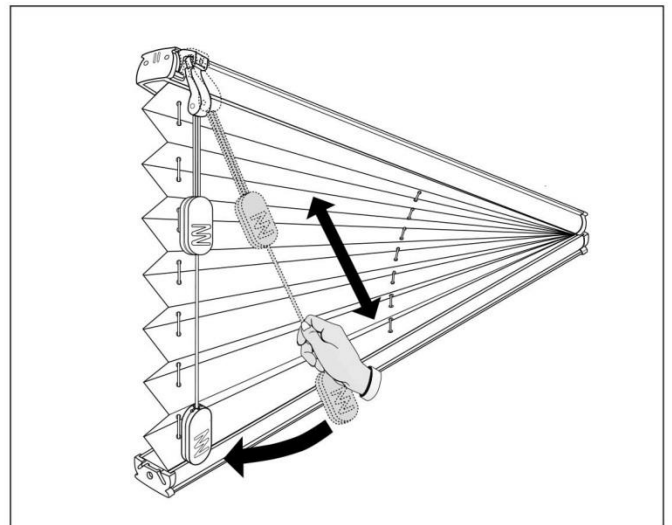

6

7

Dieses dreieckige Plisseemodell ist speziell für diese Art von Fensterform entwickelt worden. Der Behang ist nicht beweglich, d.h. dieses Plissee kann nicht geöffnet werden.

Die Fertigung ist mit einfachen und Wabenplissee-Stoffen möglich. Bitte beachten Sie, dass bei der Verwendung von Wabenplissee- oder Duo-Stoffen der Mindestabstand zwischen Scheibe und Stoff mindestens 17 mm betragen sollte.

Alle [Montageanleitungen](#) - nach Modellen geordnet